

## Balun Common Mode

Wire-Wound SMD

## BCM2012 -Series

## BCM2012 type

---

BCM2012

[0805 inch]

## ◆ SHAPE & DIMENSIONS

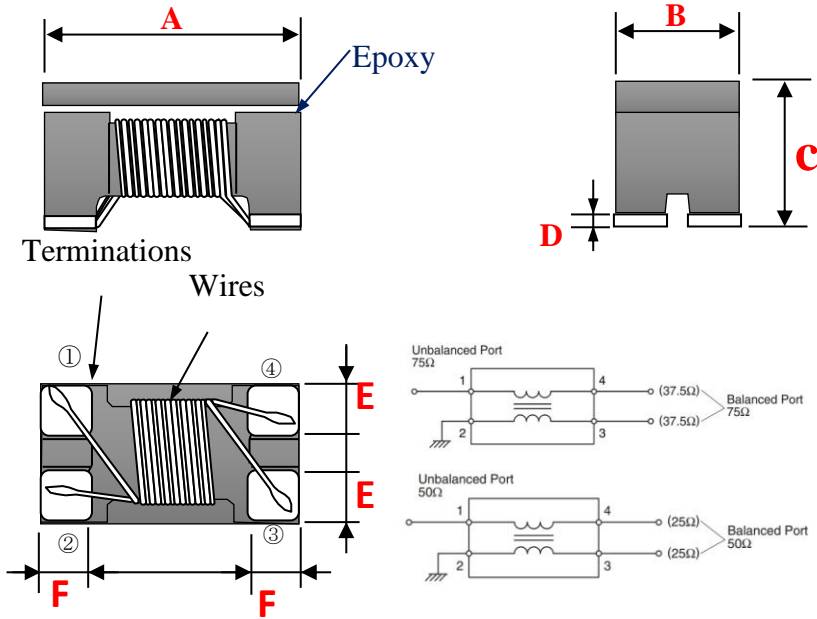

BCM2012	Dimensions
<b>A</b>	2.0 ± 0.2
<b>B</b>	1.2 ± 0.2
<b>C</b>	1.2 ± 0.2
<b>D</b>	0.2 ± 0.1
<b>E</b>	0.40 Typ
<b>F</b>	0.45 Typ

## ◆ PART NUMBER CONSTRUCTION

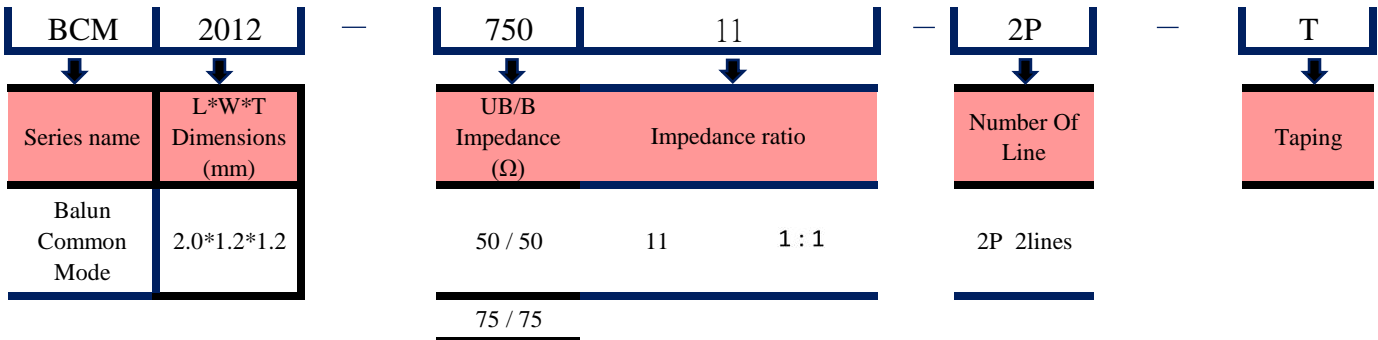

## ◆ OPERATING TEMPERATURE RANGE, PACKAGE QUANTITY.

Type	Temperature range		Reel Dimensions (mm)	Package quantity (pieces/reel)
	Operating Temperature °C	Storage Temperature °C		
BCM2012-Series	-40 to +85	-40 to +85	ø180	2,000

## ◆ ELECTRICAL CHARACTERISTICS

UB/B Impedance ( $\Omega$ )	Freq. Range (MHz)	Insertion Loss (dB)		CMRR (dB) typ.	Rated Voltage (V) max.	DC Resistance ( $\Omega$ ) max.	Rated Current (mA)max.	Insulation Resistance (M $\Omega$ )min.	Part No.
		typ.	max.						
50 / 50	40~1800	1.0	2.2	15	20	0.50	150	10	BCM2012-50011
75 / 75	50~1200	0.8	1.2	20	20	0.70	280	10	BCM2012-75011

## ◆ Measurement

Measurement Item	Meter	Manufacturer
DC Resistance	16502	Chroma
Insulation Resistance	4339B	Agilent
Insertion loss	E5071C	Keysight
Return loss	E5071C	Keysight

## ◆ PERFORMANCE CURVES

BCM2012-50011

□ INSERTION LOSS

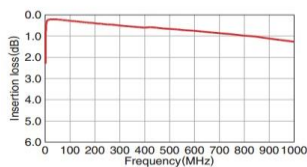

□ RETURN LOSS

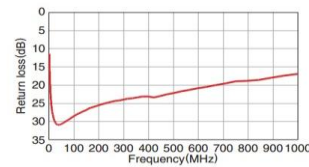

□ AMPLITUDE IMBALANCE

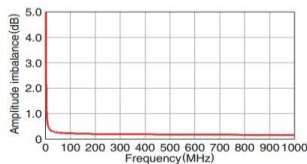

□ PHASE BALANCE

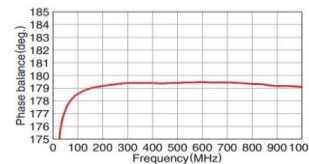

BCM2012-75011

□ INSERTION LOSS

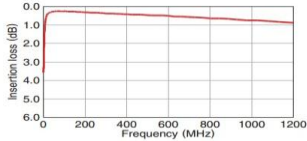

□ RETURN LOSS

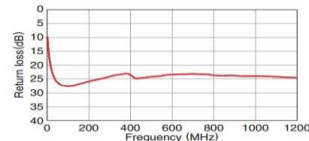

□ AMPLITUDE IMBALANCE

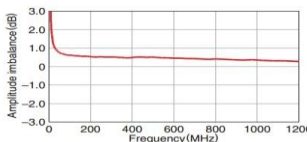

□ PHASE BALANCE

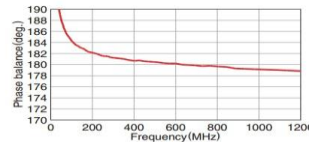

## ◆ Recommended Soldering Conditions (Please use this product by reflow)

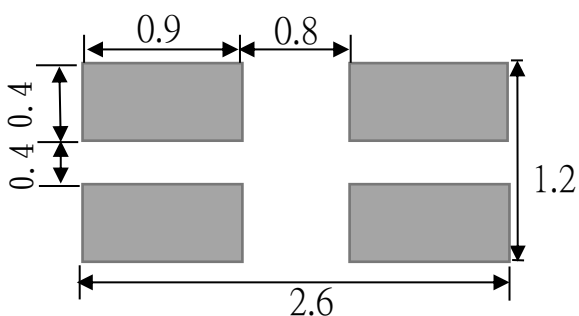

# RELIABILITY

## ◆ RECOMMENDED REFLOW PROFILE

2017/11/1

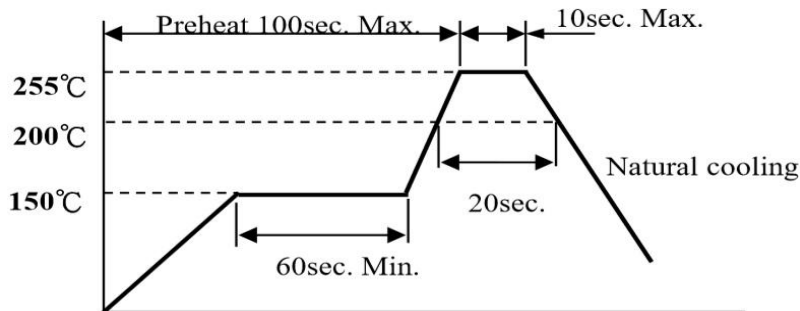

## ◆ MECHANICAL RELIABILITY

TEST ITEM	Specification & Requirement	Method Used
Solderability	The surface of terminal/pin tested shall be covered with new solder by 90%	Solder heat proof: Preheating: 150 ± 10°C 60 seconds Soldering: 245 ± 5°C for 4 ± 1 sec
Solder Heat Resistance	Components should have not evidence of Impedance: within ± 15% of initial value	Preheating: 150°C 60secs Flux: rosin Dip time: 10 ± 0.5 secs
Terminal strength	Series No.	F (Kg)
	CMC2012F/H/S	0.5
	CMC/P3216F	1.0
	CMC/P3225F	1.0
	CMC/P4532F	1.2
<b>ENDURANCE RELIABILITY</b>		
Thermal Shock	Impedance change within ± 15% Without mechanical damage	-65°C, (30 mins) -> room temp. (2 mins) 125°C, (30 mins) -> room temp. (2 mins) 50 cycles
Humidity Resistance		Apply IDC current @ 60°C ambient Humidity: 90%
Low Temp. Storing		Duration: 168 hrs Storing Temp. -40 ± 2 °C for total 168 +5/-0 hours
High Temp. Storing		Storing Temp. 125 ± 2 °C for total 168 +5/-0 hours

## ◆ Reel Dimension & Tape Dimension

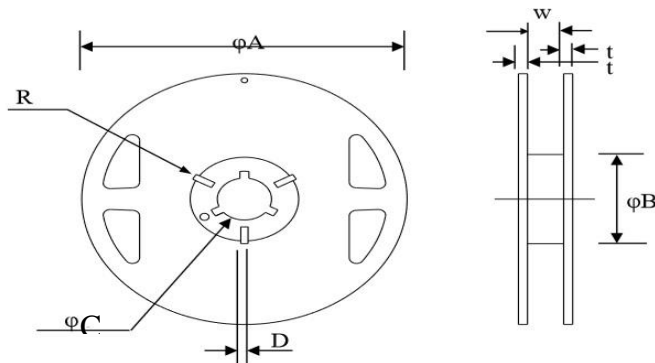

Type	A(mm)	B(mm)	C(mm)	W(mm)
7"x8mm	178±1	60±0.5	13.5±0.5	9.5±0.5
7"x12mm	178±1	60±1	13.3±0.5	13.7±0.5

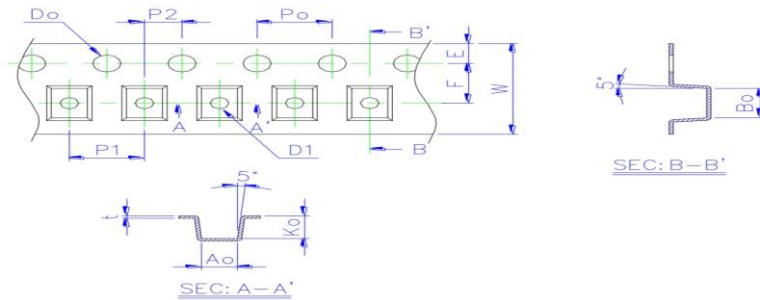

Size	Ao(mm)	Bo(mm)	Ko(mm)	W(mm)	E(mm)	F(mm)	Po(mm)	P1(mm)	Do(mm)
2012	1.50±0.05	2.35±0.05	1.45±0.05	8.00±0.20	1.75±0.10	3.50±0.05	4.00±0.05	4.00±0.10	1.50+0.10/-0.00
3216	1.88±0.05	3.50±0.05	2.10±0.05	8.00±0.20	1.75±0.10	3.50±0.05	4.00±0.05	4.00±0.10	1.50+0.10/-0.00
3225	2.88±0.10	3.65±0.10	2.50±0.10	8.00±0.10	1.75±0.10	3.50±0.05	4.00±0.10	4.00±0.10	1.50+0.10/-0.00
4532	3.45±0.10	4.90±0.10	3.05±0.10	12.00±0.20	1.75±0.10	3.50±0.05	4.00±0.05	8.00±0.10	1.50+0.10/-0.00

## ◆ Cover Tape Peel Strength

The force for tearing off cover tape is 0.05~0.69(N) in the arrow direction at the following conditions:

Temperature : 5 ~ 35°C

Humidity : 45 ~ 85%

Atmospheric pressure : 860 ~ 1060 hpa

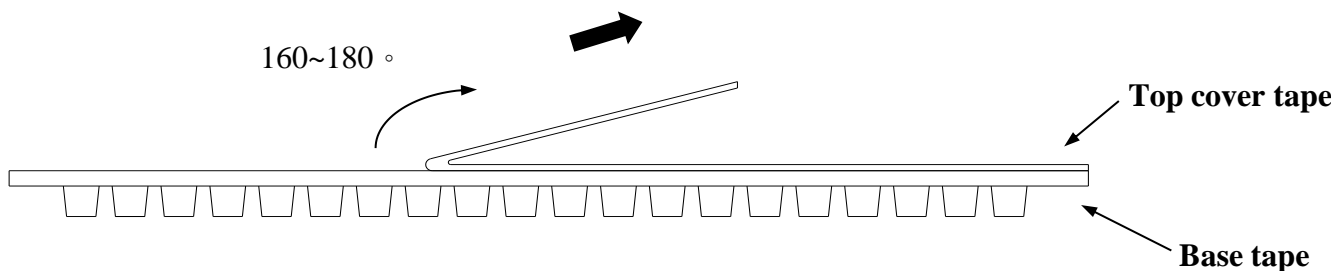

## ◆ Packaging Quantity

Chip Size	2012	3216	3225	4532
8mm / Reel	2000	2000	1000	500